

EVERY MOMENT COUNTS



N+1 Parallel



Easy
Communication



Hot
Swappable



Power Share



DSP
Digital Signal
Processing



• **ablerex MS II** - PARALLEL ON-LINE UPS
FOR MISSION CRITICAL USER

 **Ablerex**
every moment counts

The Ablerex MSII Parallel On-Line UPS, is the perfect solution for mission critical users who demand high reliability, availability and performance for critical electronic equipment and computer loads.

It features double conversion True Online Technology, field-proven full Digital Signal Processor (DSP) and utilises our uniquely patented inverter control technology. The Ablerex MSII Parallel On-Line UPS is a scalable system which achieves N + 1 redundancy without any additional parts.

Simple Parallel Installation(No extra PCB require)

Install for operation in parallel to increase power capacity or make redundant system. Simply connect the parallel control lines through the RJ-45 connector on the rear panel with CAM-bus and communication is established to all units. The maximum parallel operation configuration is 4 units.

Full Digital Signal Processor (DSP) Control

Provides both pure sine waves at the output and perfect sine waves to the input current to ensure compatibility with all kinds of loads. Full DSP technology also allow :

- **Programmable Frequency Converter**

Reprogram the UPS to be a Frequency Converter for either 50Hz or 60Hz through front keypad configuration.

- **Easy-to-Set User Personalization**

Through the LCD front panel, you can easily change the built-in parameters and settings of the DSP controllers, such as UPS operation modes voltage configurations, synchronization frequency windows, bypass voltage tolerance and buzzer alarm status.

- **Intelligent Self-Diagnostics**

Through the self-diagnostics inside the DSP, system faults can be pin-pointed rapidly which results in faster repair times easier servicing. Simply access the service mode and check each device step by step, through the results displayed on the LCD display.

- **Smart Fan Control**

The speed of the internally mounted cooling fans are controlled according to load percentage to reduce noise levels and energy consumption.

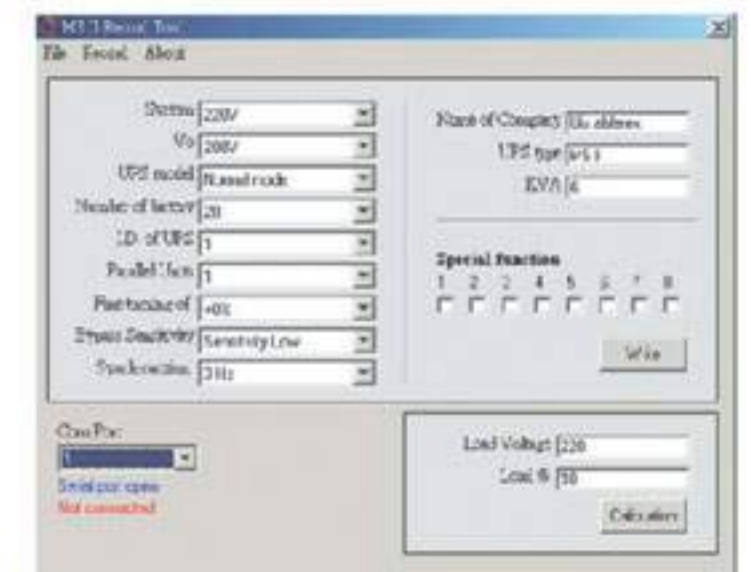

True Double Conversion On-Line Technology

Corrects power disturbances from the utility power and regenerates clean and safe AC power. The Voltage Frequency Independent (VFI) working mode of the UPS complies with EN60240-3 ,European Directives for True-On-Line Technology.

High Input Power Factor and Low Current THD

Provides a clean rectifier connection to the utility power. It meets today's industry standards for energy saving and low current harmonic pollution to the utility power and achieves up to 0.99 at Input Power Factor as well as <5% Current THD.

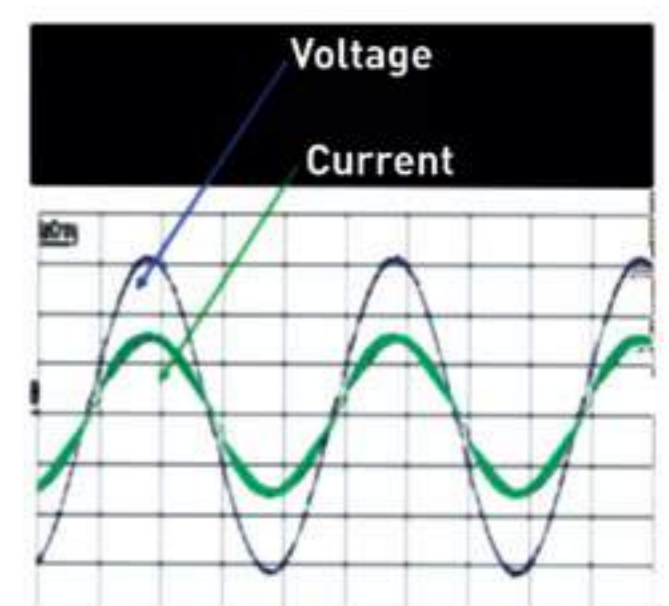

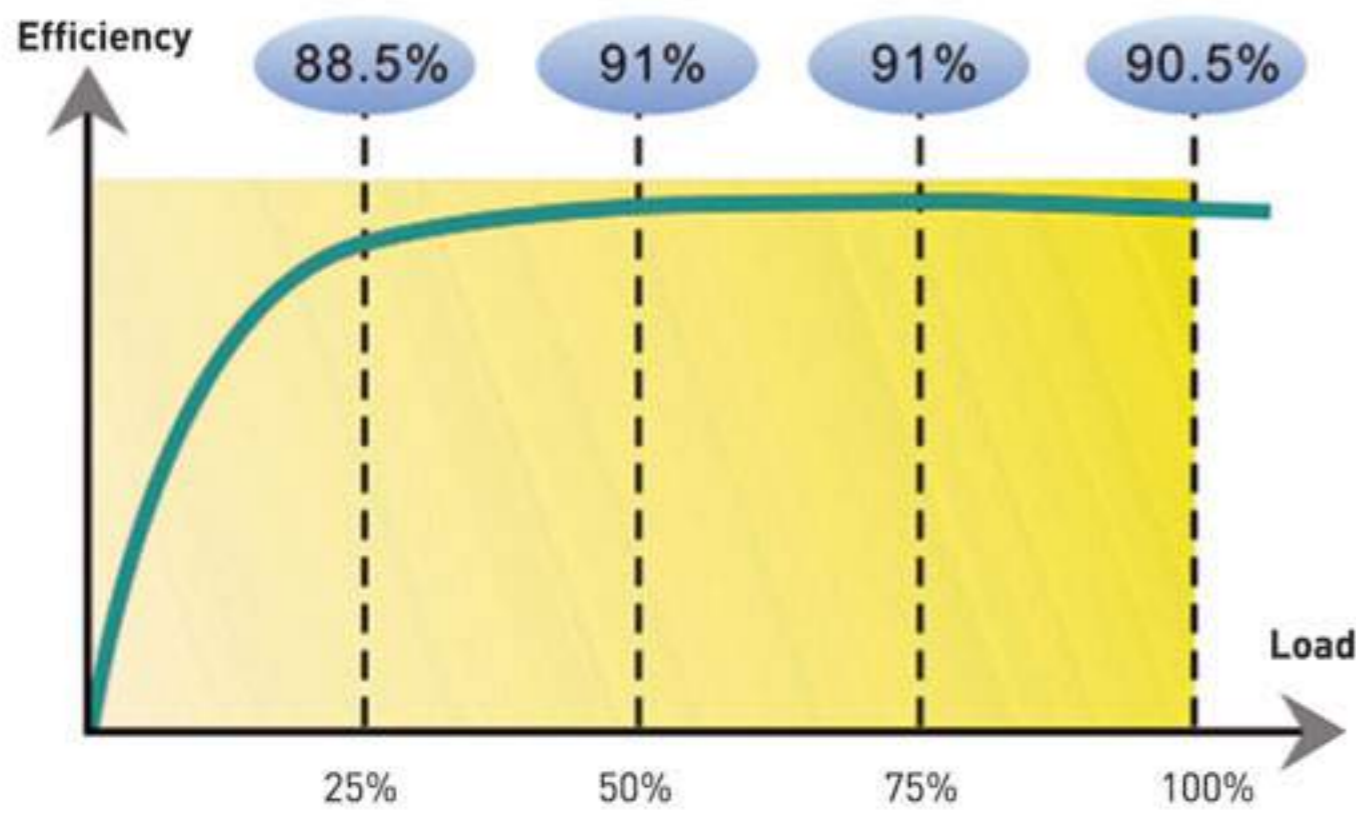

Energy-efficient UPS

The AC to AC efficiency of the UPS reaches up to 90% at 50% load and better at larger loadings. Using the ECO mode, efficiencies of up to 98% can be achieved.

Dual Input Option

Comes with single input connections as standard. Separate input terminals for the bypass and rectifier can be provided as an option. In addition, dual input version allows the configuration of a 3-phase input & 1-phase output systems of 18KVA capacity.

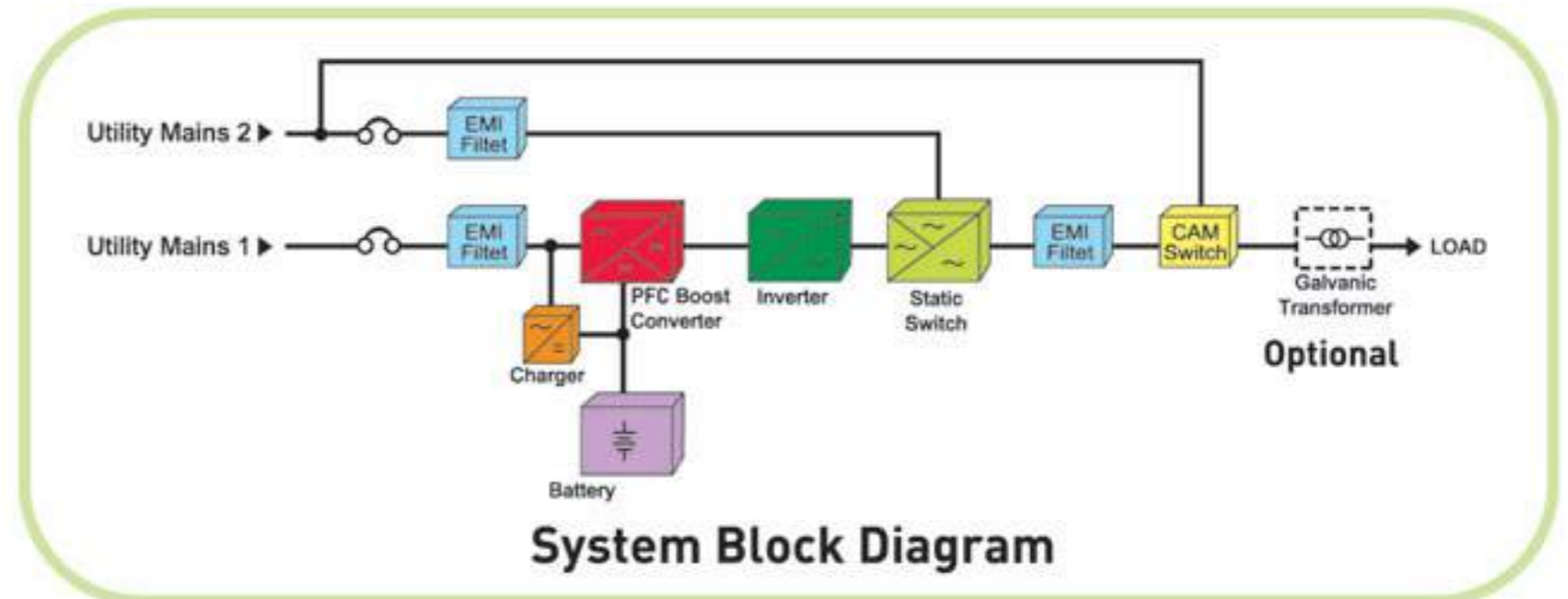

LCD/LED Mimic Panel

An easy-to-read front panel LCD/LED display provides real-time status of all major system parameters and statuses such as operation modes, AC voltage, frequency, battery voltage, load level, inner temperature, etc.

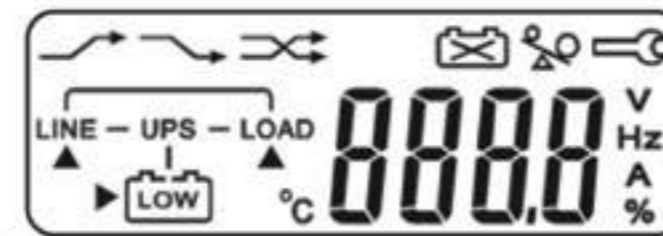

2 X Customer Options Slots

The UPS also provides two additional Customer Option Communication slots in addition to the standard RS232 port. All communication cards are designed for easy installation as electrical connections are made through a 26-pin edge card connector. The first RS232 port on the rear panel will remain active, when other optional communication card(s) are installed.

Optional EPO Function

Enables users to perform one-touch emergency shutdown of the UPS remotely via dry contact relay.

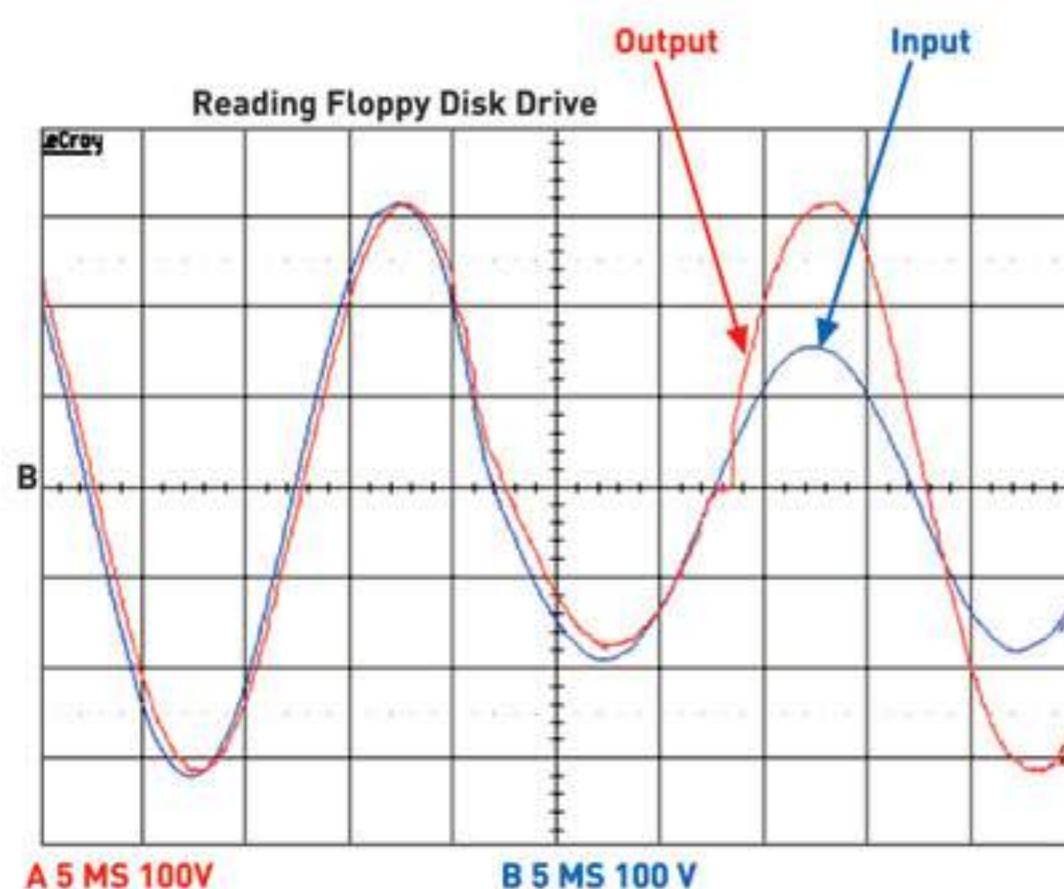

Smart ECO Mode

In ECO operation mode, power is supplied to load via Bypass Utility. It will automatically transfer to controlled inverter supply instantly without any break, if Bypass Utility is out of tolerance or unavailable.

Built-In Maintenance Manual Bypass

It ensures continuous supply of power to the critical load during service or periodical maintenance of the UPS system. The built-in Manual Bypass Switch is electrically interlocked with the inverter to provide safe operation. An External Maintenance Bypass switchbox is available for complete unit hot swap. (Optional, please check with your dealer)

i-Batt

Automatically manages end of discharge voltage according to load capacity. The i-Batt function prevents deep-discharge of the built-in battery during a power failure with ultra low load conditions.

Cold Start Function

Enables users to turn on the UPS without connecting to the utility.

Power Range and Runtime Scalability

The Ablerex MSII UPS provides excellent return on investment. The system is fully modular, which allows you to increase the overall power output, battery runtime and redundancy as your system grows. It is important however that you design your electrical installation to support your needs.



MSII 8KVA/10KVA

Optional Galvanic Isolated Transformer

The galvanic isolation transformer not only provides a complete isolation between input and output, but also allow various secondary voltages such as 220/230/240Vac, 208Vac/120Vac and 240Vac/120Vac. This provides an intrinsic safety between input and output either at normal system mode or at bypass mode. (refer to system block diagram)

Communication Capability

The UPS is equip with monitoring/shutdown software as standard. The software not only allows the control of the UPS and its scheduled shutdown when the utility power fails, but also allows the user to

- Remotely test the major operating functions of the UPS
- Communicate via SNMP/WEB card
- Access UPS functions via the WEB

Optional External Battery Charger Box (1000Watts / 4Amps)

The optional charger box, with its isolated conversion technology plus precision control, can be installed in parallel operation of up to 4 charges. The specifications are as follows;



AC Input Range:	100-280Vac, 45-65Hz
Maximum Power Output:	1000W, continuously
Operation Mode:	Constant Voltage with Current Limitation
Maximum Parallel Units	Up to 4 charges
Protections:	Over-temperature, Over-voltage, Against Output Short-circuit & Isolated devices for Opposite polarity Connection
Mounting:	Mounted on the rear of the UPS or wall mounted

Matching Battery Cabinet Connectivity

Standard matching battery cabinets are available to extend the UPS runtime easily to several hours.

Optional Hot Swappable Battery Connectivity

The Ablerex UPS allows you to replace battery packs without the hazard of electric shock, while UPS supplies continuously power to your applications.

Model	MSII 6KVA	MSII 8KVA/10KVA	MSII15KVA	MSII20KVA
INPUT				
Voltage	160 ~ 280Vac*	160 ~ 280Vac* (1P / 1P) 277 ~ 485Vac (3P / 1P)	277 ~ 485Vac (3P / 1P)	
Frequency	45 ~ 65 Hz			
Phase / Wire	Single, Line + Neutral + Ground			
Power Factor	Up to 0.99 at 100% Linear Load			
Current THD	<5% at 100% Linear Load			
OUTPUT				
Voltage	200/220/230/240Vac Selectable (208/120Vac Optional)			
Voltage Adjustment	Nominal + 1%, +2%, +3%, -1%, -2% or -3% adjustable			
Voltage Regulation	+/-2%			
Capacity	6000VA/5400W	8000VA/7200W , 10000VA/9000W	15000VA/13500W	20000VA/18000W
Rated Power Factor	0.9 lagging			
Wave From/Distortion	Sine Wave, Voltage THD <3% (no load to full load)			
Frequency Stability	+/-0.2% On Inverter Free-Running Mode			
Frequency Regulation	+/-1Hz, +/-3Hz (programmable by user)			
Transfer Time	0msec			
Crest Factor	3:1 acceptable			
Efficiency (AC to AC, Normal)	Up to 90%			
Efficiency (AC to AC, ECO mode)	Up to 95%			
Autonomy (Built-in Battery)	~15-30 mins depending on Load			
DC Start	Yes			
BATTERY				
Type	Sealed Lead Acid Maintenance Free			
Capacity	7AH	7AH-MSII 8KVA 9AH-MSII 10KVA	9AH or 12AH	
Quantity	60pcs	60pcs	9AH-60pcs	12AH-40pcs
Voltage	240Vdc			
Recharge Time	4 Hours to 90%			
Supplementary charger	Optional 1000W Isolated Charger			
DISPLAY				
Status on LED + LCD	Line Mode, Backup Mode, ECO Mode, Bypass Supply, Battery Low, Battery Bad/Disconnect, Overload, Transferring with Interruption, & UPS Fault			
Readings on LCD	Input Voltage, Input Frequency, Output Voltage, Output Frequency, Load Percentage, Battery Voltage & Inner Temperature.			
Self-Diagnostics	Upon Power-on & Front Panel Setting			
PROTECTION				
Overload (with simulated thermal tripping I-T curve)	AC Mode : <105% continuously >106% ~ 120% for 30 sec		>121% ~ 150% for 10 sec >150% immediately	
	Bypass Mode: <105% continuously >106% ~ 120% for 250 sec shut down >121% ~ 130% for 125 sec shut down >131% ~ 135% for 50 sec shut down >136% ~ 145% for 20 sec shut down		>146% ~ 148% for 5 sec shut down >149% ~ 157% for 2 sec shut down >158% ~ 176% for 1 sec shut down >177% ~ 187% for 0.32 sec shut down >188% for 0.16 sec shut down	
Short Circuit	Inverter Switch Off Immediately			
Overheat	AC mode : Switch to Bypass Backup Mode : UPS shuts down immediately			
Battery Low	Alarm and Switch off			
Noise Suppression	Complies with EN62040-2			
Spike Suppression	Complies with EN61000-4-5			
ALARMS				
Audible and Visual	Line Failure, Battery Low, Transfer to Bypass, System Fault Condition			

ablerex **MSII** TECHNICAL SPECIFICATIONS

Model	MSII 6KVA	MSII 8KVA/10 KVA	MSII 15KVA	MSII 20KVA
PHYSICAL				
Dimensions (W x D x H)	290 x 645 x 748 mm			
Standard unit	290 x 645 x 748 mm			
with Transformer Option	-	290 x 645 x 881 mm	290 x 645 x 1041 mm	
Battery Bank Cabinet	290 x 631 x 748 mm			
Input & Output Connection	Hardwire			
External Battery Connection	Plug & Play			
Net Weight				
Standard unit	86kgs	8KVA - 87kgs	10KVA - 96kgs	60kgs
with Transformer Option	139kgs	8KVA - 140kgs	10KVA - 149kgs	130kgs
Battery Bank Cabinet	105kgs			
ENVIRONMENT				
Operating Temperature	0°C - 40°C			
Altitude	0-2000m up to 40°C, 3000m up to 35°C			
Humidity	90% RH Maximum, Non-Condensing			
Noise	<50dB (at 1 meter)			
COMPUTER INTERFACE				
Interface Type	Standard RS232 Interface			
Communication Slots	2 nd RS232 with EP0**, USB with EP0**, RS485 with EP0**, Relay Contact & EP0, SNMP/WEB Card, etc. (Optional)			
SAFETY CONFORMANCE				
Quality Assurance	ISO9001 Certified Company			
Safety Standard	EN50091-1, UL1778			
EMC Standard	EN50091-2, EN61000-3-2, EN61000-3-3, FCC Class A			
Marks	CE, UL, cUL			

*160 - 176Vac at ≤75% load
 **These cards are not suitable to use simultaneously
 Specifications subject to change without prior notice.

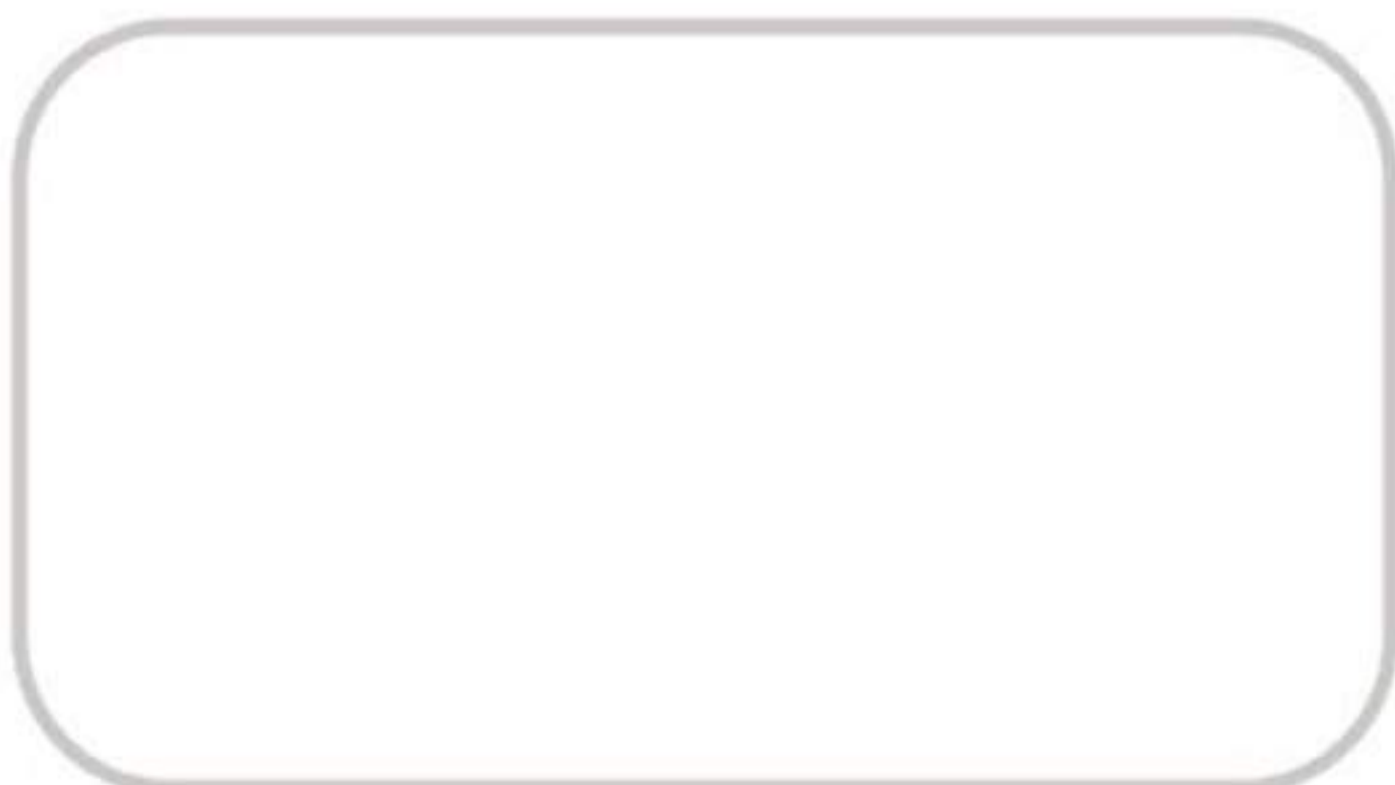

DESIGNED AND ENGINEERED BY :



Ablerex Electronics (S) Pte Ltd
 23 New Industrial Road #05-03
 Solstice Business Center
 Singapore 536209
 Tel: +65 6282 6535
 Fax: +65 6282 6343
 Email: sales@ablerex.com.sg
 www.ablerex.com.sg